

**SEPARADORES DE GORDURAS E  
FÉCULAS  
NORMA EUROPEIA - EN 1825  
POLIETILENO ALTA DENSIDADE**

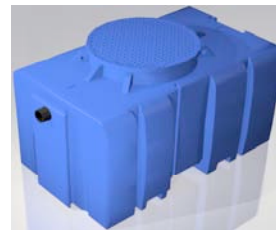

## Separador de Gorduras e Féculas - Funcionamento

---



1. O Separador de Gorduras e Féculas AlmAqua possui duas zonas distintas: uma zona de decantação de sólidos; e outra de separação dos óleos e gorduras.
2. No primeiro compartimento será feita a decantação de féculas e restos de comida provenientes do efluente sujo.
3. Por deflecção, o efluente é conduzido ao segundo compartimento, onde se realiza a decantação das gorduras, por diferenças de densidade.
4. A saída do efluente do segundo compartimento é feita no ponto mais baixo.
5. O Separador de Gorduras deverá ser limpo quando atingir a sua capacidade máxima de armazenamento de óleos e gorduras.

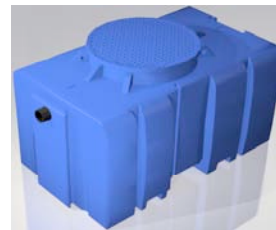

## SEPARADOR DE GORDURAS E FÉCULAS

### SGD 3 c/ Decantador

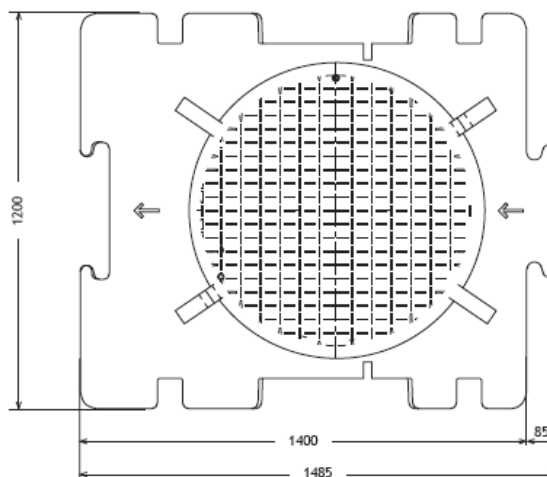
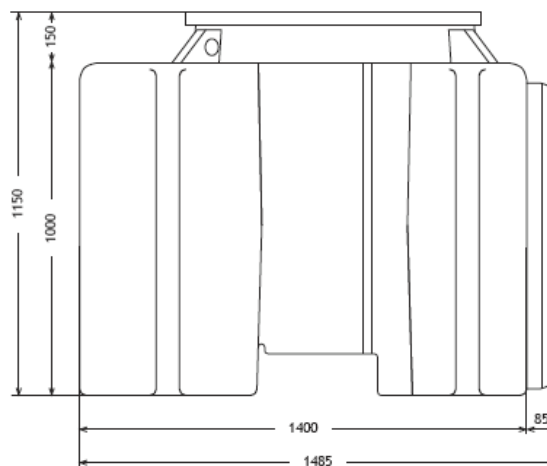
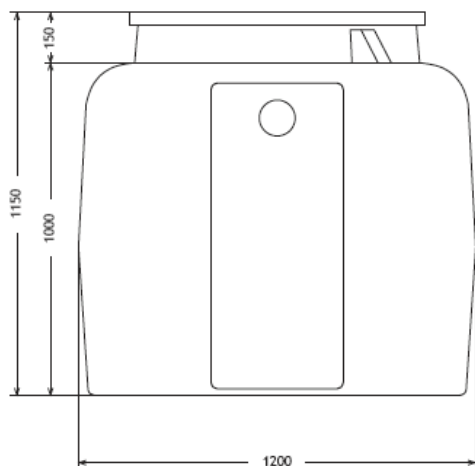

### PEAD

MOD.	Caudal (l/s)	C (mm)	L (mm)	A (mm)	DN (mm)	Dec. (Litros)	Sep. (Litros)	Peso (Kg)
SGD 3	3	1485	1200	1150	110	300	700	80

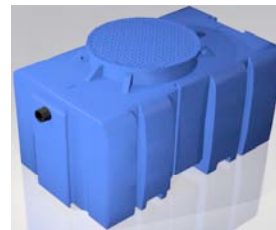

## SEPARADOR DE GORDURAS E FÉCULAS

### SGD 6 c/ Decantador

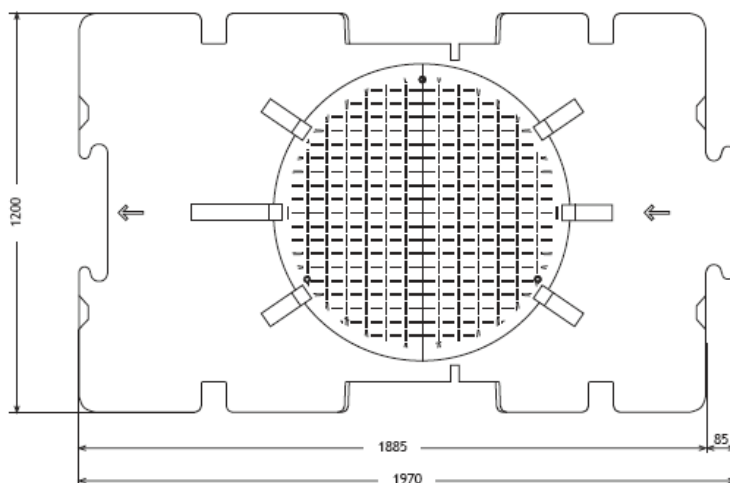
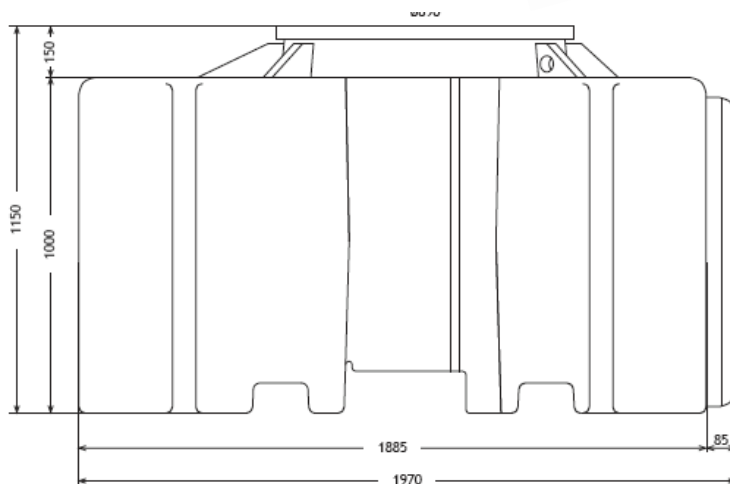
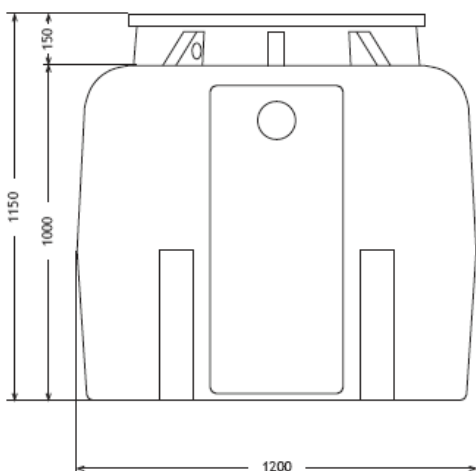

### PEAD

MOD.	Caudal (l/s)	C (mm)	L (mm)	A (mm)	DN (mm)	Dec. (Litros)	Sep. (Litros)	Peso (Kg)
SGD 6	6	1970	1200	1150	110	1 000	1 000	90

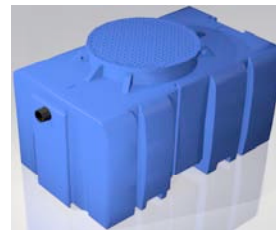

## SEPARADOR DE GORDURAS E FÉCULAS

### SGD 8\_c/ Decantador

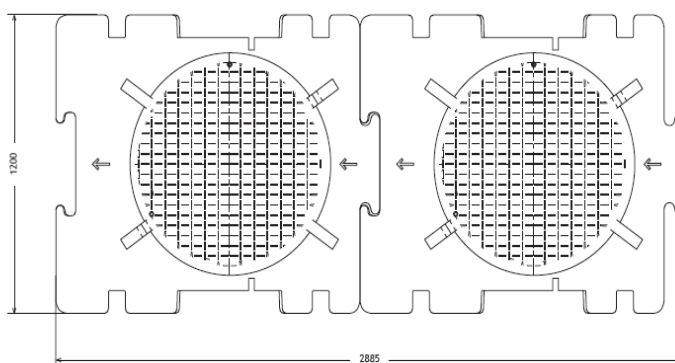
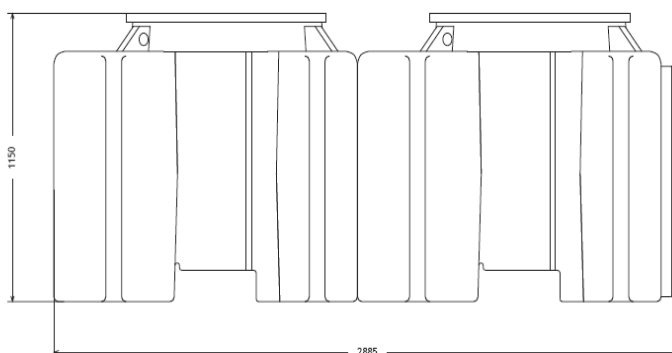
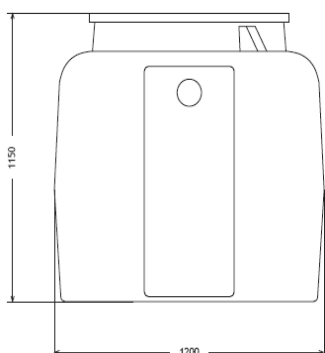

## PEAD

MOD.	Caudal (l/s)	C (mm)	L (mm)	A (mm)	DN (mm)	Dec. (Litros)	Sep. (Litros)	Peso (Kg)
SGD 8	8	2885	1200	1150	110	1 500	1 500	160

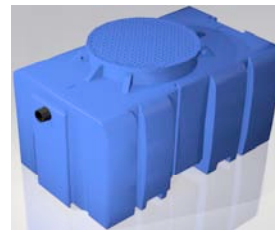

## SEPARADOR DE GORDURAS E FÉCULAS

### SGD 10 c/ Decantador

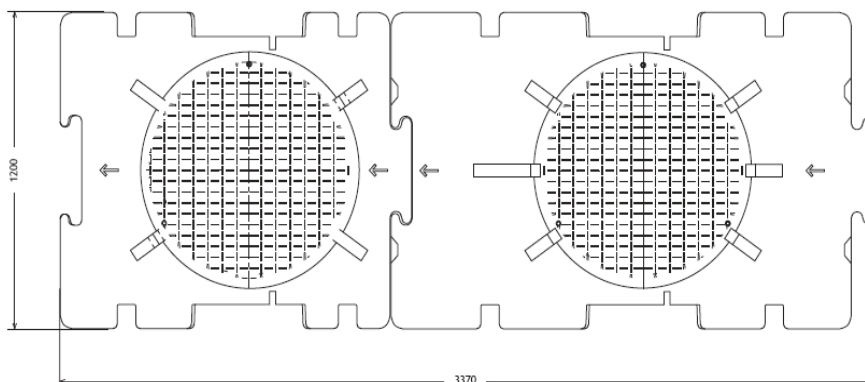
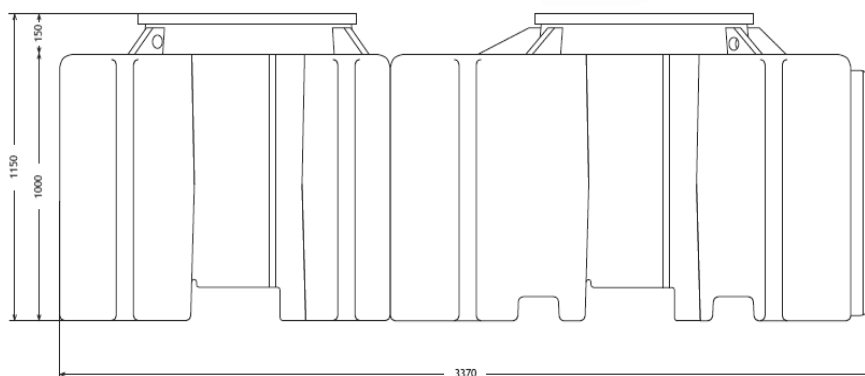
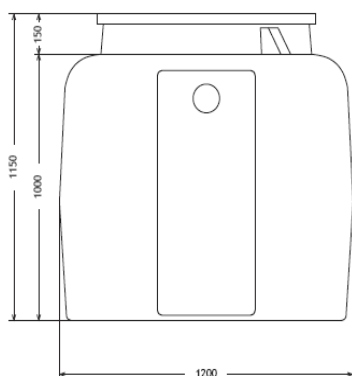

### PEAD

MOD.	Caudal (l/s)	C (mm)	L (mm)	A (mm)	DN (mm)	Dec. (Litros)	Sep. (Litros)	Peso (Kg)
SGD 10	10	3370	1200	1150	160	1 500	2 000	170

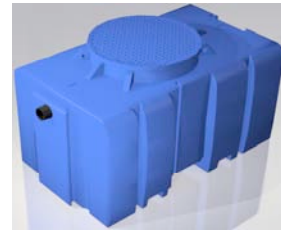

## SEPARADOR DE GORDURAS E FÉCULAS

### SGD 15 c/ Decantador

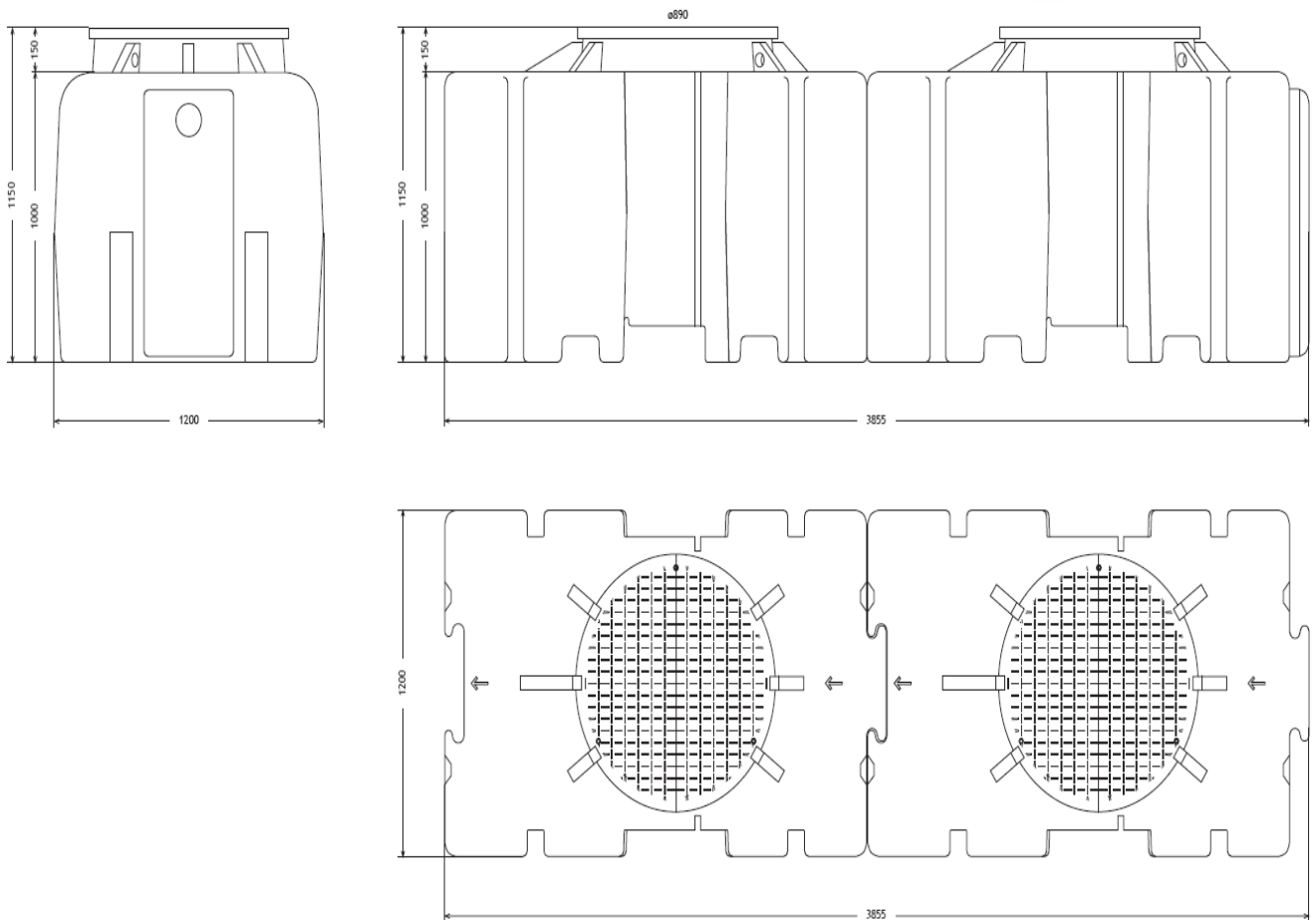

## PEAD

MOD.	Caudal (l/s)	C (mm)	L (mm)	A (mm)	DN (mm)	Dec. (Litros)	Sep. (Litros)	Peso (Kg)
SGD 15	15	3855	1200	1150	160	2 000	2 000	180

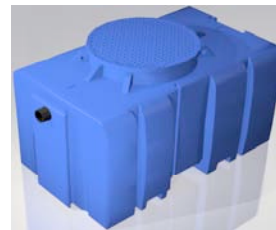

## SEPARADOR DE GORDURAS E FÉCULAS

### SGD 20 c/ Decantador

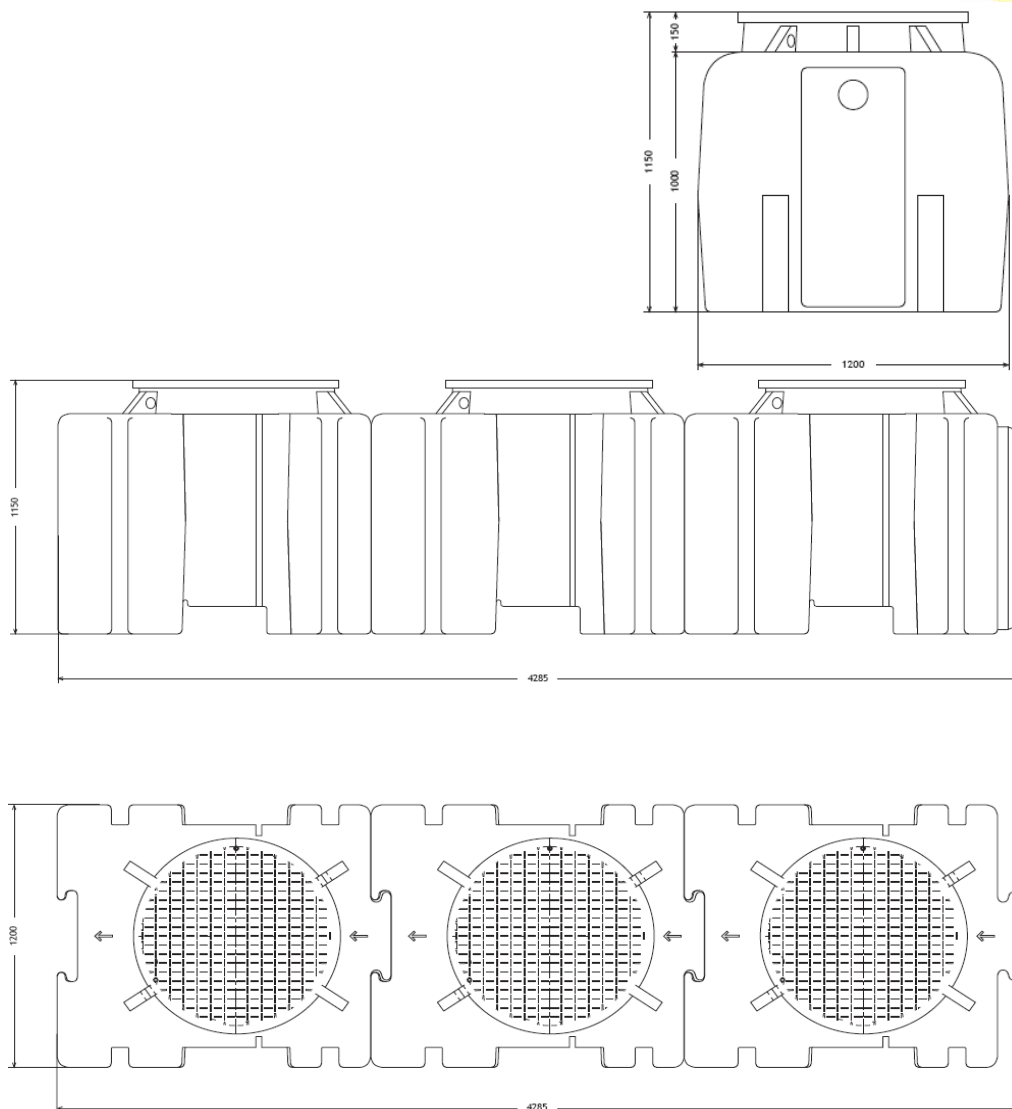

### PEAD

MOD.	Caudal (l/s)	C (mm)	L (mm)	A (mm)	DN (mm)	Dec. (Litros)	Sep. (Litros)	Peso (Kg)
SGD 20	20	4285	1200	1150	200	2 250	2 250	240